

PAVEMENT BREAKER 90 lb class SPB-90

Sullivan Palatek®



THOR™ TYPE

Dedicated to Quality....

....Committed to Support

Designed for heavy demolition jobs, rock, reinforced concrete, and 5" or 6"+ thick concrete and pavement.

- 4 bolt backhead
- Heavy duty side rod bolts and springs
- Forged alloy construction
- Removable front head
- Replaceable chuck bushing
- Internal oiler
- Optional muffler
- One year warranty
- Manufactured in USA

Specifications		
Net weight	92.5 lbs	42 kg
Length	28.75 in	730 mm
Bore	2.625 in	66.67 mm
Stroke	6.0625 in	154 mm
Blows per minute	1250	1250
Models and Chuck Sizes:		
SPB 90 1 1/4" P/N SI777-4	1 1/4 x 6 in	32 x 154 mm
SPB 90 1 1/8" P/N SI777-8	1 1/8 x 6 in	28 x 154 mm
Air inlet (NPT)	3/4 in	19 mm
Air consumption*	75 cfm	2.1 m ³ /m
*estimated		

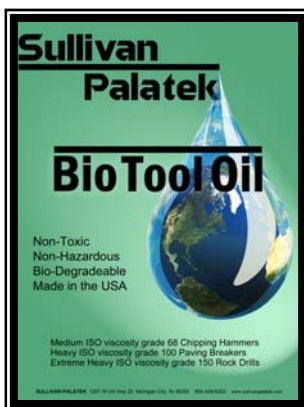

FOR OPTIMUM PERFORMANCE, DO NOT OPERATE TOOL ABOVE 90 PSI (6 BAR) WORKING PRESSURE.

FOR START UP **YOU MUST FILL OIL RESERVOIR** WITH ISO 100 TOOL OIL, TOOLS ARE SHIPPED DRY (RE-TIGHTEN OIL PLUG!). USE ISO 100 TOOL OIL IN BREAKERS, P/N SI9017 BIO TOOL OIL

WARNING:

ALWAYS DISCONNECT THE AIR SUPPLY BEFORE CHANGING CHISELS OR DISMANTLING THE TOOL FOR SERVICE OR REPAIR. FOR MAXIMUM SAFETY WE ADVISE THE INSTALLATION OF A SHUT-OFF VALVE AT THE END OF THE AIR LINE.

DO NOT EXCEED 100 PSI (7BAR) WORKING PRESSURE.

Sullivan Palatek®

1201 West US Highway 20
Michigan City, IN 46360

Ph: 800-438-6203
Fx: 800-725-6203

info@palatek.com
www.sullivanpalatek.com

PARTS LIST PAVEMENT BREAKER 90 lb class SPB-90

- WHEN ORDERING NEW TOOLS SPECIFY CHUCK SIZE.
- WHEN ORDERING REPLACEMENT PARTS, FURNISH THE MODEL NUMBER AND SERIAL NUMBER(S) OF YOUR TOOLS.

USE ISO GRADE 100 TOOL OIL IN YOUR BREAKERS. WE OFFER ISO 100 BIO TOOL FOR ALL OF OUR TOOLS, SEE BELOW.

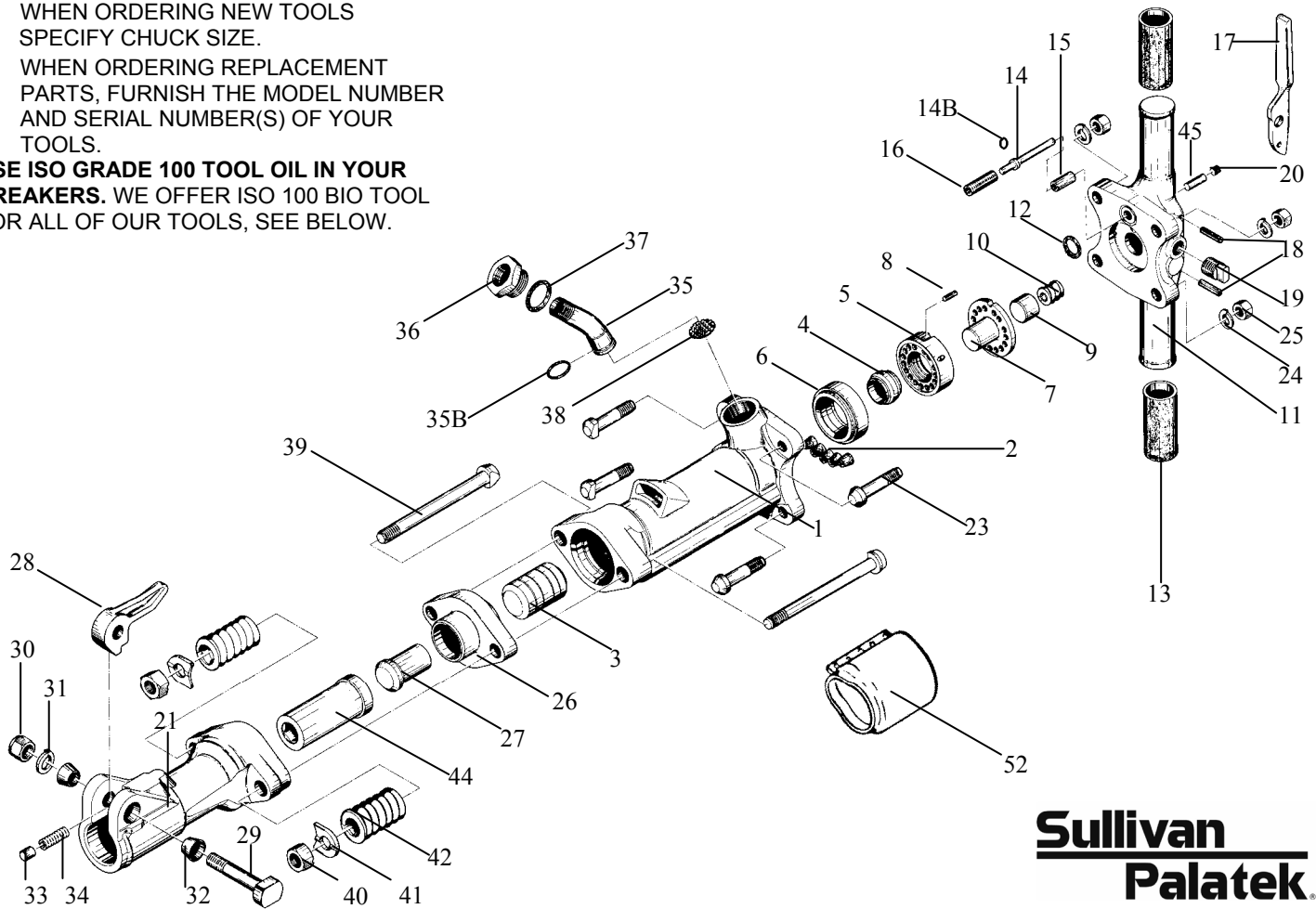

**Sullivan
Palatek**

INDEX	PART	DESCRIPTION	INDEX	PART	DESCRIPTION
1	SI6001	CYLINDER	29	SI6629	STEEL RETAINER BOLT
2	SI6602	CYLINDER PLUGS (5)	30	SI6630	STEEL RETAINER BOLT NUT
3	SI6003	PISTON	31	SI6631	STEEL RETAINER LOCKWASHER
4	SI6604	AUTOMATIC VALVE	32	SI6632	RETAINER BOLT BUSHING(RUBBER)(2)
5	SI6005	VALVE CHEST	33	SI6633	STEEL RETAINER PLUNGER
6	SI6006	VALVE SEAT	34	SI6634	RETAINER PLUNGER SPRING
7	SI6007	VALVE GUIDE	35	SI6035	AIR INLET SWIVEL
8	SI6608	VALVE DOWEL PIN	35B	SI6035B	AIR INLET SWIVEL O-RING
9	SI6609	BACKHEAD PLUNGER	36	SI6036	AIR INLET SWIVEL NUT
10	SI6610	BACKHEAD PLUNGER SPRING	37	SI6037	SWIVEL NUT O-RING
11	SI6011	BACKHEAD BARE (incl.#6615)	38	SI6038	AIR INLET SCREEN
NS	SI6011C	BACKHEAD ASSBLY. COMPLETE	39	SI6039	FRONTHEAD BOLT (2)
12	SI6612	BACKHEAD O-RING	40	SI6640	FRONTHEAD BOLT NUT(2)
13	SI6613	RUBBER GRIP (2)	41	SI6641	FRONTHEAD BOLT LOCKWASHER (2)
14	SI6614	THROTTLE VALVE	42	SI6642	FRONTHEAD BOLT SPRING
14B	SI6614B	THROTTLE VALVE O-RING	44	SI6644A	FRONTHEAD BUSHING 1-1/8"HEX
15	SI6615	THROTTLE VALVE SLEEVE	44	SI6644B	FRONTHEAD BUSHING 1-1/4"HEX
16	SI6616	THROTTLE VALVE SPRING	45	SI6645	OIL CONTROL FELT
17	SI6617	THROTTLE LEVER	NS	SI6046	FRONTHEAD w/1-1/8" HEX BUSHING
18	SI6618	THROTTLE LEVER PIN (2)	NS	SI6047	FRONTHEAD w/1-1/4" HEX BUSHING
19	SI6019	OIL RESERVOIR PLUG	NS	SI6048	FRONTHEAD ASSBLY. w/1-1/8" HEX
20	SI6620	OIL CONTROL FELT PLUG	NS	SI6049	FRONTHEAD ASSBLY.w/1-1/4" HEX
21	SI6021	FRONTHEAD BARE	NS	SI6050	OIL TANK PLUGS (2)
NS	SI6022	FRONTHEAD - SPIKE DRIVER	52	SI6052	MUFFLER ASSBLY.(OPTIONAL)
23	SI6023	BACKHEAD BOLT (4)	NS	SI9017	BIO OIL, BREAKER 100 ISO, 1 QUART
24	SI6624	BACKHEAD BOLT LOCKWASHER (4)	KIT	SI9011	FRONTHEAD BOLT KIT 90
25	SI6625	BACKHEAD BOLT NUT (4)	KIT	SI9013	BREAKER LATCH KIT 60 & 90
26	SI6026	TAPPET SEAT			
27	SI6027	TAPPET			
28	SI6628	STEEL REAINER (FORGED)			

Service Tips: 1. Tighten fronthead bolts to where nut is has about 3 threads showing on the end of the bolt. Do not over tighten.
2. Cross tighten and torque backhead bolts to 75 ft. lbs.
3. Consult factory for whip hose with oiler and other accessories.